

Low Noise Amplifier

ZX60-P103LN+

50Ω

50 to 3000 MHz

The Big Deal

- Ultra Low Noise Figure, 0.5 dB typ.
- High Dynamic Range



Case Style: GC957

Product Overview

The ZX60-P103LN+ (RoHS compliant) uses Mini-Circuits' E-PHEMT technology to offer ultra low noise figure over a broad frequency range and high IP3. Housed in a rugged, cost effective unibody chassis, this amplifier supports a wide variety of applications requiring moderate power output, low distortion and 50 ohm matched input/output ports.

Key Features

Feature	Advantages
Ultra Low Noise Figure, 0.5 dB at 1GHz	Outstanding world class noise figure performance.
High IP3 vs. DC power consumption 39.4 dBm typical at 1 GHz	Combining Low Noise and High IP3 makes this model ideal for use in Low Noise Receiver Front End (RFE)
Max. Input Power, +25 dBm	Ruggedized design operates to high input powers often seen at receiver inputs.
Very Small Size, 0.75" x 0.75"	The unique unibody size and construction enable the ZX60-P103LN+ to be used in extremely compact connectorized applications.

Notes

A. Performance and quality attributes and conditions not expressly stated in this specification document are intended to be excluded and do not form a part of this specification document.

B. Electrical specifications and performance data contained in this specification document are based on Mini-Circuit's applicable established test performance criteria and measurement instructions.

C. The parts covered by this specification document are subject to Mini-Circuits standard limited warranty and terms and conditions (collectively, "Standard Terms"); Purchasers of this part are entitled to the rights and benefits contained therein. For a full statement of the Standard Terms and the exclusive rights and remedies thereunder, please visit Mini-Circuits' website at www.minicircuits.com/MCLStore/terms.jsp



Coaxial Low Noise Amplifier

ZX60-P103LN+

50Ω 50 to 3000 MHz

Features

- wideband, 50 to 3000 MHz, usable to 3500 MHz
- low noise figure, 0.5 dB typ.
- output power up to 22.5 dBm typ.
- ESD protection at input
- protected under US Patent 8,803,612

Applications

- front-end amplifier
- cellular
- GPS
- bluetooth
- lab
- instrumentation
- test equipment



Case Style: GC957
Connectors Model
SMA ZX60-P103LN+

+RoHS Compliant
The +Suffix identifies RoHS Compliance. See our web site for RoHS Compliance methodologies and qualifications

Electrical Specifications at 25°C

Parameter	Condition (MHz)	Min.	Typ.	Max.	Units
Frequency Range		50		3000	MHz
Noise Figure	50		1.2		dB
	500		0.4		
	1000		0.5		
	2000		0.6		
	3000		1.0		
Gain	50	23.0	25.2		dB
	500	18.0	20.3		
	1000	13.5	15.6		
	2000	8.0	10.0		
	3000	4.5	6.9		
Output Power @ 1 dB compression	50		19.8		dBm
	500		22.3		
	1000		22.4		
	2000		23.2		
	3000		23.8		
Output IP3	50		36.9		dBm
	500		39.7		
	1000		39.4		
	2000		42.6		
	3000		44.3		
Input VSWR	50		2.15		dB
	500		1.91		
	1000		1.65		
	2000		1.48		
	3000		1.27		
Output VSWR	50		1.27		dB
	500		1.10		
	1000		1.47		
	2000		2.36		
	3000		1.80		
Active Directivity (Isolation-Gain)	50		6.46		dB
	500		5.82		
	1000		6.27		
	2000		6.99		
	3000		7.01		
DC Supply Voltage		—	5.0	—	V
Supply Current		—	95	120	mA

Notes

- Performance and quality attributes and conditions not expressly stated in this specification document are intended to be excluded and do not form a part of this specification document.
- Electrical specifications and performance data contained in this specification document are based on Mini-Circuit's applicable established test performance criteria and measurement instructions.
- The parts covered by this specification document are subject to Mini-Circuits standard limited warranty and terms and conditions (collectively, "Standard Terms"); Purchasers of this part are entitled to the rights and benefits contained therein. For a full statement of the Standard Terms and the exclusive rights and remedies thereunder, please visit Mini-Circuits' website at www.minicircuits.com/MCLStore/terms.jsp



Maximum Ratings

Parameter	Ratings
Operating Temperature	-40°C to 85°C Case
Storage Temperature	-55°C to 100°C
DC Voltage	5.5 V
Input RF Power (no damage)	+21 dBm
Power Consumption	0.66 W

Permanent damage may occur if any of these limits are exceeded.

Outline Drawing

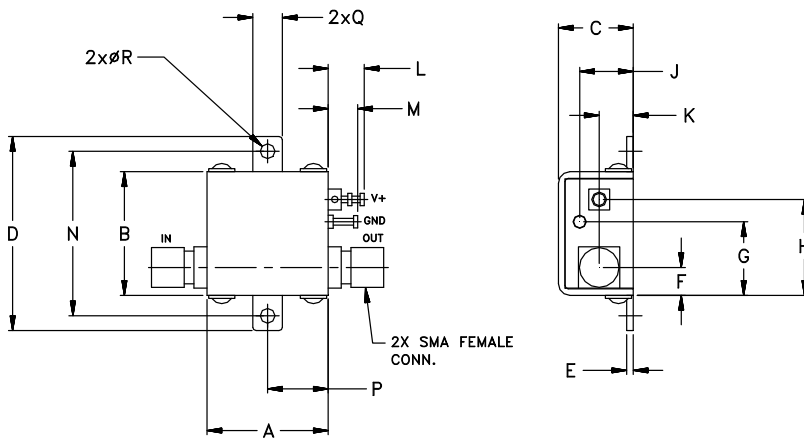

! NOTE: When soldering the DC connections, caution must be used to avoid overheating the DC terminal. See Application Note. [AN-40-010](#).

Outline Dimensions (inch/mm)

A	B	C	D	E	F	G	H	J	K	L	M	N	P	Q	R	wt
.74	.75	.46	1.18	.04	.17	.45	.59	.33	.21	.22	.18	1.00	.37	.18	.106	grams
18.80	19.05	11.68	29.97	1.02	4.32	11.43	14.99	8.38	5.33	5.59	4.57	25.40	9.40	4.57	2.69	23.0

Notes

- Performance and quality attributes and conditions not expressly stated in this specification document are intended to be excluded and do not form a part of this specification document.
- Electrical specifications and performance data contained in this specification document are based on Mini-Circuit's applicable established test performance criteria and measurement instructions.
- The parts covered by this specification document are subject to Mini-Circuits standard limited warranty and terms and conditions (collectively, "Standard Terms"); Purchasers of this part are entitled to the rights and benefits contained therein. For a full statement of the Standard Terms and the exclusive rights and remedies thereunder, please visit Mini-Circuits' website at www.minicircuits.com/MCLStore/terms.jsp

FREQUENCY (MHz)	GAIN (dB)	DIRECTIVITY (dB)	VSWR (:1)		POUT at 1dB COMPR. (dBm)	NOISE FIGURE (dB)	OUTPUT IP3 (dBm)
			IN	OUT			
50.00	25.29	6.46	2.13	1.25	19.9	1.2	37.0
100.00	25.05	5.47	2.12	1.13	20.1	0.6	37.9
400.00	21.49	5.82	1.93	1.04	22.4	0.4	39.4
800.00	17.27	6.18	1.73	1.29	22.7	0.4	40.1
1200.00	14.22	6.42	1.59	1.67	22.7	0.5	40.6
1600.00	11.92	6.66	1.51	2.06	23.0	0.5	41.4
2000.00	10.03	6.99	1.53	2.37	23.5	0.5	42.6
2400.00	8.60	7.06	1.41	2.37	23.6	0.6	43.8
2800.00	7.25	7.43	1.21	1.99	23.8	1.1	45.7
3000.00	6.95	7.01	1.23	1.80	24.0	0.9	44.3

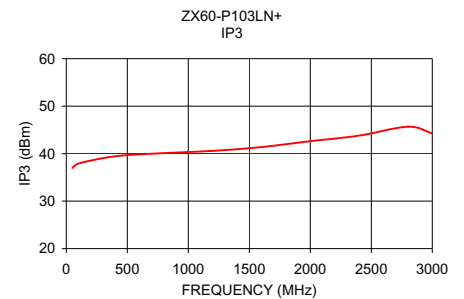
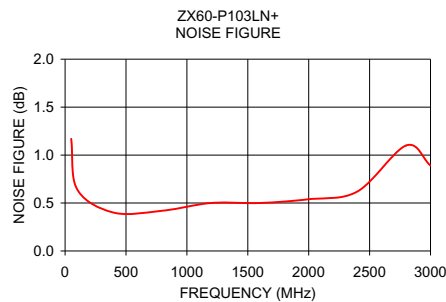
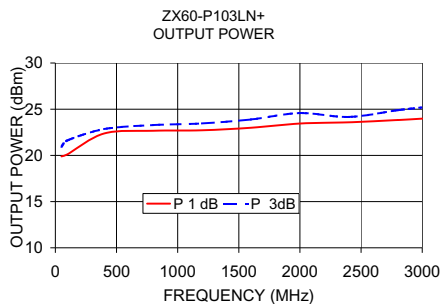
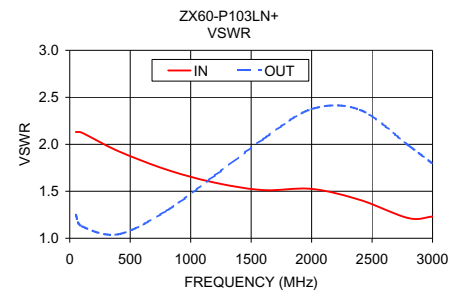
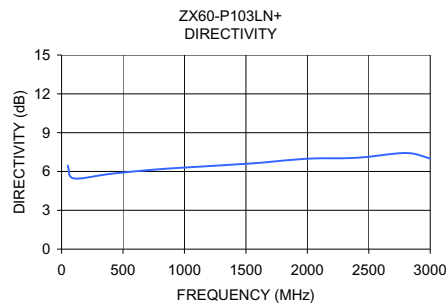
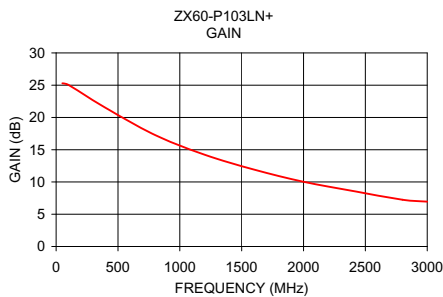

Notes

- A. Performance and quality attributes and conditions not expressly stated in this specification document are intended to be excluded and do not form a part of this specification document.
- B. Electrical specifications and performance data contained in this specification document are based on Mini-Circuit's applicable established test performance criteria and measurement instructions.
- C. The parts covered by this specification document are subject to Mini-Circuits standard limited warranty and terms and conditions (collectively, "Standard Terms"); Purchasers of this part are entitled to the rights and benefits contained therein. For a full statement of the Standard Terms and the exclusive rights and remedies thereunder, please visit Mini-Circuits' website at www.minicircuits.com/MCLStore/terms.jsp

